

# Refrigeration for Superconductors

RAY RADEBAUGH

## *Invited Paper*

*Temperatures in the range of 0.05 to 80 K are required for most applications of superconductors. Refrigeration powers range from fractions of a watt for many electronic applications to kilowatts for some large magnet and power applications. This paper reviews the various types of refrigeration methods currently available to meet the needs of various applications of superconductors. The methods covered include mainly the gas cycles, which are divided into the recuperative types (steady flow), such as the Joule-Thomson, Brayton, and Claude cycles, and the regenerative types (oscillating flow), such as Stirling, Gifford-McMahon, and pulse tube cycles. Methods for reaching millikelvin temperatures are briefly mentioned as well. The operating principles of the various methods are described, and the advantages and disadvantages of each are given to help the user understand which approach may work best for a particular application. All cryogenic refrigeration methods have a common set of problems that have hindered many applications of superconductors. These problems and recent developments to overcome some of these problems are discussed.*

**Keywords**—Applications, cooling, cryocoolers, cryogenics, superconducting devices, superconducting magnets, superconducting power systems, superconductors.

## I. INTRODUCTION

### A. Applications of Cryocoolers

Cooling of superconducting electronics, magnets, and power systems is the main application of cryocoolers discussed in this paper. However, it is useful to note that cryocoolers are used in a very wide range of applications. It is important to understand some of these other applications because coolers developed for those cases may be adapted for cooling superconductors with little or no modifications. The sharing of cryocooler development with other applications is important in reducing the often significant problem of the cost of cryocoolers.

Table 1 lists some of the more common applications of cryocoolers. Cryocoolers are required for a wide and expanding variety of applications as cryocoolers are improved.

Manuscript received December 19, 2003; revised April 21, 2004.

The author is with the Cryogenic Technologies Group, National Institute of Standards and Technology, Boulder, CO 80305 USA (e-mail: radebaugh@boulder.nist.gov).

Digital Object Identifier 10.1109/JPROC.2004.833678

One of the earliest applications appeared about 50 years ago for cooling infrared sensors to about 80 K to enhance the capability of night vision for the military. To date, over 140 000 Stirling cryocoolers have been produced for tactical military applications [1]. Refrigeration powers vary from about 0.15 to 1.75 W, which are appropriate for many high-temperature superconductor (HTS) electronic applications. The use of HTS microwave filters for cellular phone base stations has become the largest application of HTS, with more than 4000 systems now in the field. Refrigeration powers are around 6 W at 77 K. In the last decade or so, the desire for night-vision surveillance and missile detection from satellites has prompted extensive research on improved cryocoolers to meet the stringent requirements for space use.

The use of HTS cables for superconductor power applications requires considerably higher refrigeration powers. These applications include motors, generators, transformers, fault-current limiters (FCL) and transmission lines. Fig. 1 shows a map of all the application areas for cryocoolers on the plane of refrigeration power versus temperature. The superconducting applications are shown as crosshatched regions in this figure.

Cryopumps are the largest commercial application for cryocoolers and produce the very clean vacuums required by the semiconductor industry in fabricating circuits with extremely narrow linewidths. Cryopumps contain a charcoal bed cooled to about 15 K with a Gifford-McMahon (GM) cryocooler that pumps all gases and leaves no trace of oil contamination in the vacuum space. These two-stage cryocoolers cryotrap water vapor on baffles cooled to about 80 K with the first stage in order to prevent loading of the charcoal with the water vapor. During the peak of semiconductor production, about 20 000 cryopumps per year were produced, but this has declined some in the last few years.

The largest application of superconductors is for magnets in magnetic resonance imaging (MRI) systems. About 1000 systems per year are being produced. Magnetic fields of 1.5–3 T are typical for these magnets, with the higher fields providing better resolution. Liquid helium is generally used in cooling these NbTi coils to 4 K. Cryocoolers are used in these cryostats in a few different ways. Originally,

U.S. Government work not protected by U.S. copyright.

**Table 1**  
Some Common Applications of Cryocoolers

**Military**

1. Infrared sensors for missile guidance and tactical applications
2. Infrared sensors for surveillance (satellite based)

**Police and Security**

1. Infrared sensors for night vision and rescue

**Environmental**

1. Infrared sensors for atmospheric studies of ozone hole and greenhouse effects

**Commercial**

1. Cryopumps for semiconductor fabrication
2. High temperature superconductors for cellular-phone base stations
3. Superconductors for voltage standards
4. Infrared sensors for NDE and process monitoring

**Medical**

1. Cooling superconducting magnets for MRI systems
2. SQUID magnetometers for heart and brain studies
3. Liquefaction of oxygen for storage at hospitals and home use
4. Cryogenic catheters and cryosurgery

**Transportation**

1. LNG for fleet vehicles
2. Superconducting magnets in maglev trains

**Energy**

1. LNG for peak shaving
2. Supercond. mag. energy storage for peak shaving and power conditioning
3. Superconducting power applications (motors, transformers, etc.)

**Agriculture and Biology**

1. Storage of biological cells and specimens

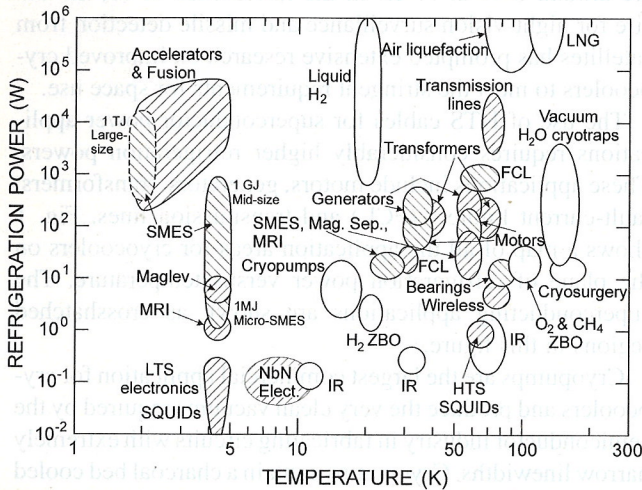

**Fig. 1.** Map of cryocooler applications in plane of refrigeration power versus temperature. Superconductivity applications are shown as crosshatched regions.

GM cryocoolers were used for cooling 20 K shields to significantly reduce the boiloff of the liquid helium. More recently, 4 K GM cryocoolers of typically 1–1.5 W are used to reliquefy the helium boiloff or they are used for conduction cooling the magnets in a dry system. Pulse tube cryocoolers have just recently been used for this application, particularly for head imagers, where low vibration is needed to prevent distortion of the MRI signal. In low-field MRI systems that employ permanent magnets (0.1–0.5 T) the use of HTS radio frequency sensor coils can greatly increase the signal-to-noise ratio, making them more competitive with the superconducting magnet systems.

**Table 2**  
Potential Cryocooler Problems

- Reliability
- Efficiency
- Size and weight
- Vibration
- Electromagnetic Interference (EMI)
- Heat rejection
- Cost

A large demand now exists for high-field (around 20 T) superconducting magnets for use in nuclear magnetic resonance (NMR) spectrometers for investigating the structure of macromolecules, such as proteins, in solutions. These magnets are cooled with liquid helium. Cryocoolers have not been used, even for reliquefaction, in these systems because their vibration can degrade the signal quality. Improved cryocoolers with less vibration, such as pulse tube refrigerators, may lead to the future use of cryocoolers in this application.

Refrigeration powers for the many superconducting magnets and RF cavities used in large-scale particle accelerators for high-energy physics experiments are typically tens of kilowatts at 4.2 K, but some systems employ 2 K sections for the enhanced heat transfer of superfluid helium. These large helium liquefaction plants use either the Brayton or Claude cycle and have many stages of expansion turbines to attain high efficiency.

In general, low-temperature superconducting (LTS) systems must be cooled to about 4–10 K, which requires at least two stages of refrigeration and much more power input for the same refrigeration power compared with that required for HTS systems that may operate in the temperature range of 30–80 K. One-stage systems can reach temperatures down

**Table 3**  
Properties of Several Cryogenic Fluids

Property	He <sup>3</sup>	He <sup>4</sup>	Para H <sub>2</sub>	Normal H <sub>2</sub>	Ne	N <sub>2</sub>	Ar
Molecular Weight (g/mol)	3.017	4.003	2.016	2.016	20.18	28.01	39.95
Normal Boiling Point, NBP, (K)	3.191	4.230	20.28	20.39	27.10	77.36	87.30
Triple Point Temperature (K)	-	T <sub>λ</sub> = 2.177	13.80	13.96	24.56	63.15	83.81
Triple Point Pressure (kPa)	-	P <sub>λ</sub> = 5.042	7.042	7.20	43.38	12.46	68.91
Critical Temperature (K)	3.324	5.195	32.94	33.19	44.49	126.19	150.69
Critical Pressure (MPa)	0.117	0.2275	1.284	1.315	2.679	3.396	4.863
Liquid Density at NBP (g/cm <sup>3</sup> )	0.05844	0.1249	0.07080	0.0708	1.207	0.8061	1.395
Gas Density at 0 °C & 1 atm (kg/m <sup>3</sup> )	0.134	0.1785	0.08988	0.08988	0.8998	1.250	1.784
Heat of Vaporization at NBP (J/g)	7.714	20.72	445.5	445.6	85.75	199.18	161.14
Sensible Heat from NBP to 300 K (J/g)	-	1543.3	4010.5	3510.8	255.3	234.03	112.28
Heat of Fusion (J/g)	-	-	58.23	58.23	16.6	25.5	27.8
Heat of Vaporization per Volume of Liquid at NBP (J/cm <sup>3</sup> )	0.4508	2.588	31.54	31.55	103.5	160.6	224.8
Sensible Heat per Volume of Liquid at NBP (J/cm <sup>3</sup> )	-	192.8	283.9	248.6	308.1	188.7	156.6

to about 30 K, but their efficiency becomes quite small for temperatures below about 40–50 K.

### B. Refrigeration Requirements and Potential Cryocooler Problems

Fig. 1 shows the required temperatures and refrigeration powers for many of the applications discussed here. Other requirements for the refrigerators used to cool superconducting systems have to do with making the refrigeration system “invisible” to the user. That is, communication from the refrigeration system to the outside world via such mechanisms as vibration, noise, input power, heat rejection, electromagnetic interference (EMI), maintenance, failure, cost, etc., should be minor when compared with that of the total system. For example, if the refrigerator costs only about 10% of the total superconducting system package and most failures occur at locations other than in the refrigerator, then the user is not so aware of the presence of the refrigerator and can feel comfortable with its use in the system. Cryocoolers often have problems meeting the ideal system requirements, and users should be aware of these limitations. Fortunately, research and development on cryocoolers has been leading to significant improvements in all of the problem areas. Thus, the potential user also should be aware of the latest status of cryocooler performance when making decisions on the use of cryocoolers. Attributes of cryocoolers that may present problems in various applications are listed in Table 2.

In small electronic systems for terrestrial applications, the power input or efficiency may not be so important from a cost standpoint, but the heat rejection to the environment may require large heat rejection surfaces and fans. Electronic systems often require very low levels of EMI, whereas transmitted refrigerator EMI is of little concern in superconducting power applications. Most commercial applications require lifetimes of at least 3–5 years, while space applications usually require at least ten years. Cost is always an issue in commercial applications, while in space applications where the total instrument cost may be tens of millions of dollars, a \$1 million cryocooler cost is still small in comparison. Some of the problems listed in Table 2 may

be more serious in some types of cryocoolers than in others. These differences will be discussed later.

### C. Open and Closed Refrigeration Systems

Many of the problems associated with cryocoolers may be bypassed when using liquid cryogenes to provide the necessary cooling. Such a practice is very common in a laboratory environment, where cryogenes are readily available and trained personnel are present to periodically transfer the cryogenes. However, for most practical applications, the requirement of periodic cryogen transfer makes the system quite “visible” and undesirable to the user, especially in remote applications. The use of liquid cryogenes may be desirable from the standpoint of providing thermal buffering with varying heat loads and for enhancing heat transfer. In such cases the best refrigeration system may be a cryocooler that liquefies a gas such as nitrogen, neon, or helium, which is then circulated passively or actively throughout the superconducting system. The boiloff gas is returned to the cryocooler (liquefier) to be reliquefied. Such systems are closed, and there is no need to replenish the cryogen. The use of a cryocooler to liquefy the helium boiloff in a MRI system is a good example of such a closed cryogen system. In these systems, the cryogen is merely the heat transfer medium, and the user never needs to deal with the cryogen. These closed systems are usually more desirable in practical applications than open systems where the liquid cryogen must be trucked in from a remote liquefier. However, the use of a liquid cryogen, even in a closed system, limits operating temperatures to a region between the cryogen’s triple point and the critical point. However, fortunately for helium, it has no triple point, and the lower temperature limit of about 1 K is determined by the vapor pressure that can be achieved with a vacuum pump. Table 3 lists some properties of cryogenes of practical use for cooling superconductors.

## II. THERMODYNAMIC FUNDAMENTALS

Fig. 2 shows a schematic of a refrigerator and the important thermodynamic quantities associated with it. It is a closed system, so no mass crosses the system boundaries.

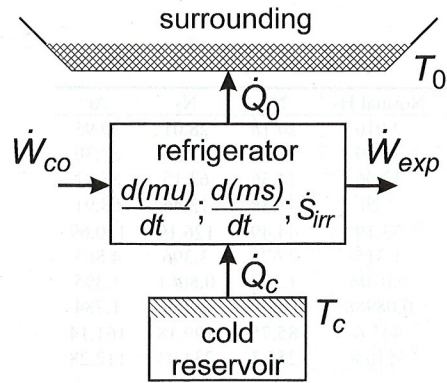

Fig. 2. Schematic of a refrigerator shown as a closed thermodynamic element along with the important thermodynamic parameters.

The function of the refrigerator is to absorb the heat flow  $\dot{Q}_c$  from a cold reservoir at a temperature  $T_c$  and reject the heat flow  $\dot{Q}_0$  to the surroundings at an ambient temperature  $T_0$ . The net input power required to operate the refrigerator is  $\dot{W}_{co}$  and the refrigerator may provide some external power flow  $\dot{W}_{exp}$  from an expander. Many refrigeration systems either produce no expansion work, or they recover the expansion work internally, in which case there still is no expansion work crossing the system boundary. Thus,  $\dot{W}_{exp}$  is often zero for a complete refrigeration system. The internal energy and the entropy of the refrigerator are given by  $mu$  and  $ms$ , where  $m$  is the mass of the refrigerator,  $u$  is the specific internal energy, and  $s$  is the specific entropy. For steady state conditions they are independent of time. The term  $\dot{S}_{irr}$  is the entropy production rate due to irreversible effects ( $\dot{S}_{irr} \geq 0$ ). For an ideal refrigerator  $\dot{S}_{irr} = 0$ . The coefficient of performance (COP) of a refrigerator in steady-state operation is defined as

$$\text{COP} = \frac{\dot{Q}_c}{\dot{W}_{co}} \quad (1)$$

and the specific power is given as

$$p_s \equiv \frac{1}{\text{COP}} = \frac{\dot{W}_{co}}{\dot{Q}_c} \quad (2)$$

The input power is usually specified as the electrical input power to the compressor. In some research papers, the input power is given as the mechanical PV (swept pressure-volume diagram) power delivered by the compressor. In other cases, the input power may be the electrical input to a power supply that converts dc power to ac power. In comparing efficiency of different cryocoolers, it is important to use the same type of input power.

A relationship between the parameters  $\dot{Q}_c, T_c, \dot{Q}_0, T_0, \dot{W}_{co}, \dot{W}_{exp}, \dot{S}_{irr}$ , and COP may be found by combining the first (energy balance) and second (entropy balance) laws of thermodynamics. With this relationship, the COP under steady-state conditions becomes

$$\text{COP} \equiv \frac{\dot{Q}_c}{\dot{W}_{co}} = \frac{T_c}{T_0 - T_c} \left[ 1 - \frac{(T_0 \dot{S}_{irr} + \dot{W}_{exp})}{\dot{W}_{co}} \right] \quad (3)$$

For an ideal refrigerator, there are no irreversible processes ( $\dot{S}_{irr} = 0$ ), and the expansion work is recovered internally ( $\dot{W}_{exp} = 0$ ) so the ideal or maximum COP, known as the Carnot value of COP, is given as

$$\text{COP}_{\text{Carnot}} = \frac{T_c}{T_0 - T_c} \quad (4)$$

The efficiency (more precisely the second law efficiency) of an actual refrigerator is usually expressed in relation to the Carnot COP as

$$\eta = \frac{\text{COP}}{\text{COP}_{\text{Carnot}}} \quad (5)$$

Fig. 3 shows the results of a 1974 survey on the efficiency of various cryogenic refrigerators and the results of a 1998 update [2], [3]. A 2002 update shows similar results [4]. Note that the efficiency of small cryocoolers is only a few percent of Carnot, but the efficiency of large systems can be as high as 40% of Carnot. This figure does not distinguish between various cycles. That comparison will be made later. The use of the second-law efficiency of (5) has the advantage of removing most of the temperature dependence. The COP or  $p_s$  are strong functions of temperature.

To evaluate the performance of individual refrigerator components where mass crosses the system boundary, the first law of thermodynamics must take into account inlet and exit enthalpies and the second law must take into account inlet and exit entropies associated with the mass flow. These terms are not shown in Fig. 2, and such analyses are not discussed here.

### III. TYPES OF CRYOCOOLERS

Fig. 4 shows the five types of cryocoolers in common use today. These are known as gas cycles, and they are able in principle to operate at temperatures from about 2 K up to 300 K. Walker presents a comprehensive review of the various types of cryocoolers [5], [6]. To achieve temperatures below 1 K either the  $^3\text{He}$ - $^4\text{He}$  dilution refrigerator or the adiabatic demagnetization refrigerator (ADR) can be used as discussed later. The Joule-Thomson (JT) and the Brayton cryocoolers are of the recuperative type in which the working fluid flows steadily in one direction, with steady low- and high-pressure lines, analogous to dc electrical systems. The compressor may have inlet and outlet valves to maintain the steady flow or for larger systems may use a scroll or screw mechanism to provide the required steady flow and compression. The recuperative heat exchangers transfer heat from the high-pressure stream to the low-pressure stream through a pressure partition. The high effectiveness required of recuperative heat exchangers for cryocoolers can be expensive to fabricate. Though not shown in Fig. 4, the Claude cycle is a Brayton cycle with the addition of a final JT expansion stage for the liquefaction of the working fluid. The Claude cycle is commonly used in large helium liquefaction systems for cooling superconducting magnets and RF cavities in accelerators.

The three regenerative cycles shown in Fig. 4 operate with an oscillating flow and an oscillating pressure, analogous to

processes  
externally  
as the

(4)

ency) of  
to the

(5)

ency of  
1998 up-  
]. Note  
percent  
as high  
between  
The use  
e of re-  
P or  $p_s$

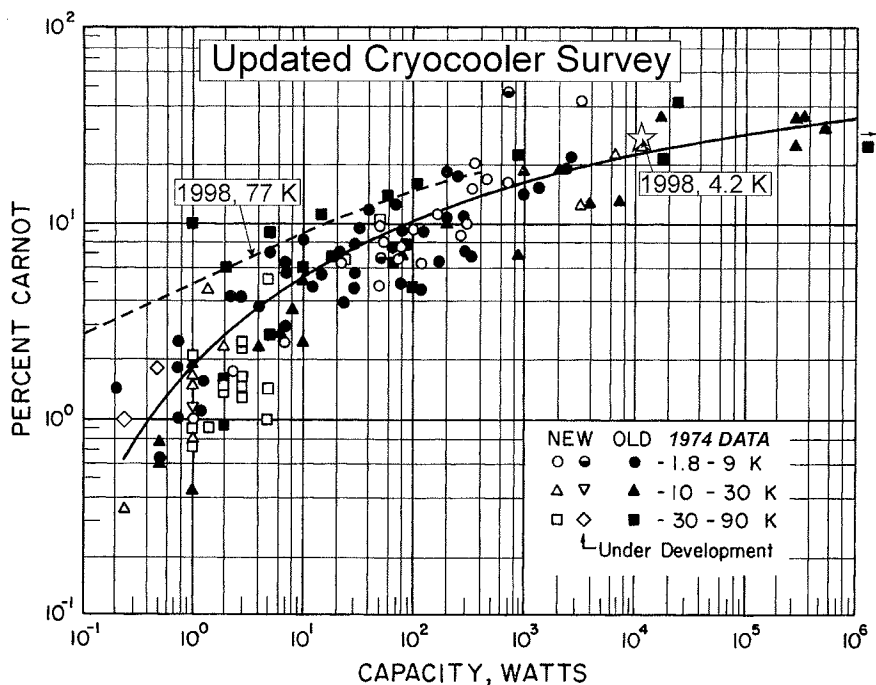

Fig. 3. Second-law efficiency of cryocoolers as a function of refrigeration power.

erator  
ary, the  
let and  
account  
. These  
are not

non use  
able in  
K up to  
the var-  
ratures  
or the  
be used

Brayton  
working

w- and  
ns. The  
tain the  
r screw  
mpres-  
from the  
ough a  
of recu-  
pensive  
e cycle  
ansion  
Claude

on sys-  
cavities

ate with  
gous to

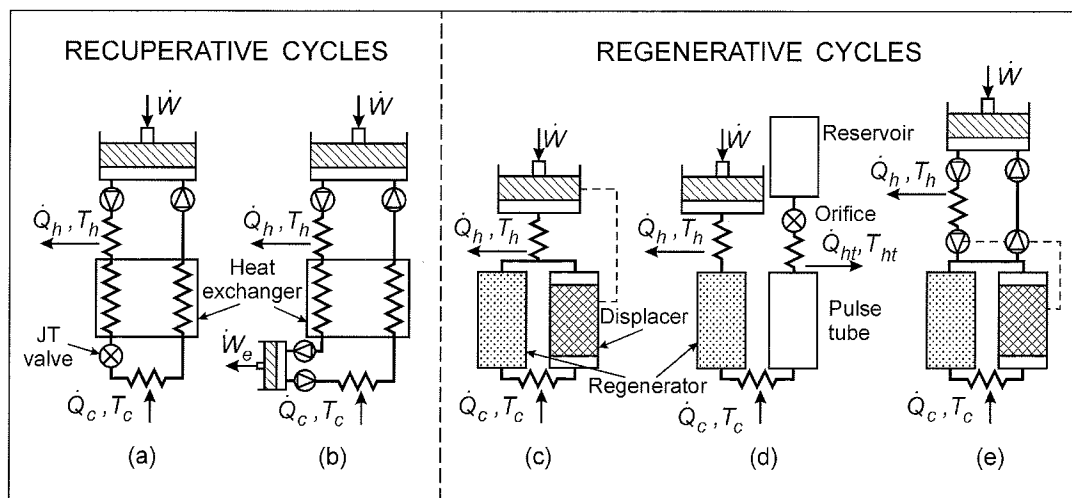

Fig. 4. Schematics of five common types of cryocoolers.

ac electrical systems. Frequencies vary from about 1 Hz for the GM and some pulse tube cryocoolers to about 60 Hz for the Stirling and some pulse tube cryocoolers. The regenerative heat exchanger (regenerator) used for these cycles has just one flow channel, which is filled with a porous matrix that has a high surface area and large heat capacity. Heat is transferred from the "hot blow" to the "cold blow" via the matrix, where the heat is stored for a half cycle in the heat capacity of the matrix. Such heat exchangers are simple to make and thus less expensive than recuperative heat exchangers.

A. *Recuperative (Steady Flow) Gas Cycles*

The steady pressure in these recuperative cryocoolers allows the use of large gas volumes anywhere in the system with little adverse effects, except for a larger radiation heat

load if located at the cold end. Thus, it is possible to "transport cold" to any number of distant locations after the gas is expanded and cooled. In addition, the cold end can be separated from the compressor by a large distance, greatly reducing the EMI and vibration originating at the compressor. Oil removal equipment with its large gas volume can also be incorporated at the compressor and ahead of the heat exchanger to remove all traces of oil from the high-pressure working gas before it is cooled in the heat exchanger. Unlike conventional refrigerators operating near ambient temperature, any oil in the working fluid will freeze at cryogenic temperatures and plug the system.

In the recuperative cycles heating of the gas occurs in the compressor during compression and cooling occurs at a particular location where the gas is expanded from the high to the low pressure. An expansion valve, orifice, capillary, or

porous plug is used in the JT cryocooler, whereas an expansion engine, such as an expansion turbine, is used in the Brayton cycle. The term "reverse-Brayton" cycle is often used in the literature to distinguish the refrigeration cycle from that of the prime mover (engine producing mechanical power from a heat source), but here we shall use the term "Brayton" to refer to both the prime mover and the refrigeration cycle. The use of the expansion engine in the Brayton cryocooler increases its efficiency compared with that of the JT cryocooler and allows it to operate with much lower pressure ratios. However, the expansion engine is a moving element that leads to increased cost and potential reliability problems.

Because the JT cycle has no cold moving parts it is easily miniaturized. Various techniques for developing microscale heat exchangers are being explored. The ease of miniaturization and the ability to separate the compressor and expansion space make the JT cycle well suited to cryogenic catheter applications. The higher efficiency of the Brayton cycle and its ability to transport cold with little or no vibration (turboexpander) makes it well suited for space applications where efficiency and low vibration are important, such as with space telescopes, and cost is of secondary importance.

1) *JT Refrigerators*: JT refrigerators or cryocoolers produce cooling when the high-pressure gas expands through a flow impedance (orifice, valve, capillary, porous plug), often referred to as a JT valve. The expansion occurs with no heat input or production of work; thus, the process occurs at a constant enthalpy. The heat input occurs after the JT expansion and warms the cold gas or evaporates any liquid formed in the expansion process. In an ideal gas, the enthalpy is independent of pressure for a constant temperature, but real gases experience an enthalpy change with pressure. Thus, cooling in a JT expansion occurs only with real (nonideal) gases and at temperatures below the inversion curve. Typically, nitrogen or argon is used in JT coolers, requiring pressures of 20 MPa (200 bar) or more on the high-pressure side to achieve reasonable cooling. Such high pressures are difficult to achieve and require special compressors with short lifetimes.

The main advantage of JT cryocoolers is their lack of moving parts at the cold end, which allows them to be miniaturized, providing a very rapid cooldown. This rapid cooldown (a few seconds to reach 77 K) has made the JT cycle the first choice for cooling infrared sensors used in missile guidance systems. These coolers utilize a small cylinder pressurized to about 45 MPa with nitrogen or argon as the source of high-pressure gas. Miniature finned tubing is used for the heat exchanger. An explosive valve is used to start the flow of gas from the high-pressure bottle. After flowing through the cooler, the gas is vented to the atmosphere. In this open-cycle mode, cooling typically lasts for only a few minutes until the gas is depleted from the bottle. Commercially available 77 K miniature coolers made by etching flow channels in glass slides are used in laboratory studies of small HTS circuits. The high-pressure nitrogen is normally supplied from a gas cylinder. Fig. 5 is a photograph of such a miniature JT cooler as described by Little [7].

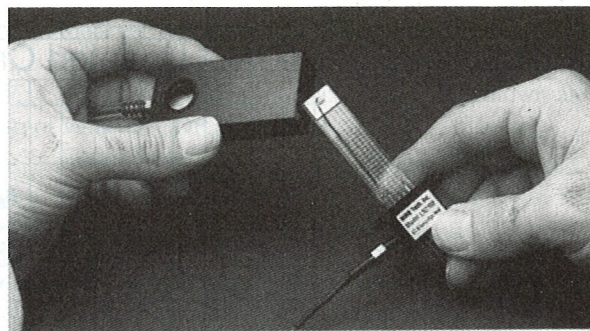

Fig. 5. Open-cycle JT cryocooler with gas channels etched in glass. Courtesy MMR.

A disadvantage of the JT cryocooler is the susceptibility to plugging the very small orifice by frozen moisture. Another disadvantage is the low efficiency when used in a closed cycle mode because compressor efficiencies are very low when compressing to such high pressures. To achieve temperatures below about 70 K with a JT cooler requires the use of a second (or third) stage with its own compressor and a neon or hydrogen (or helium) working fluid precooled by the first stage (or second stage).

Recent advances in JT cryocoolers have been associated with the use of mixed gases as the working fluid rather than pure gases. Typically, higher boiling-point components, such as methane, ethane, and propane can be added to nitrogen to make the mixture behave more like a real gas over the entire temperature range. The gas mixture in these systems undergoes boiling and condensing heat transfer in the heat exchanger, which contributes to the high efficiency of JT coolers using these mixtures. The use of mixed gases was first proposed in 1936 for the liquefaction of natural gas [8], but it was not used extensively for this purpose until the last 20 or 30 years. It is commonly referred to as the mixed-refrigerant cascade (MRC) cycle, but other names, such as the Kleemenko cycle [9] or the throttle cycle [10] are sometimes used.

The use of small JT coolers with mixed gases for cooling infrared sensors was first developed under classified programs in the Soviet Union during the 1970s and 1980s. Such work was first discussed in the open literature by Little [7]. There are several recent reviews of the use of mixed gases in JT cryocoolers [9]–[12]. The higher efficiency possible with mixed gases yields significant refrigeration with a high pressure of only 2.5 MPa. Such pressures can be achieved in conventional compressors used for domestic or commercial refrigeration, thereby reducing costs. The higher boiling point components must remain a liquid and not freeze at the lowest temperature. In general, the freezing point of a mixture is less than that of the pure fluids, so temperatures of 77 K are possible with nitrogen–hydrocarbon mixtures even though the pure hydrocarbons freeze in the range 85–91 K. The presence of propane also increases the solubility of oil in the mixture at 77 K so that less care is needed in removing oil from the mixture when using an oil-lubricated compressor. Much research is currently underway pertaining

to the solubility of oil and the freezing point in various mixtures.

With a mixture of neon, nitrogen, oxygen, and argon starting at a high pressure of 10 MPa, Luo *et al.* [13] were able to achieve a low temperature of 51 K in 1999, which may have been limited by heat exchanger ineffectiveness rather than solid formation. Other refrigerants that are not flammable, have low ozone depletion potentials, and low freezing points have been investigated in mixed-refrigerant JT systems. Practical mixed-refrigerant JT systems have achieved Carnot efficiencies near 10% for temperatures around 90 K, but their efficiencies drop off quickly for lower temperatures. By using a conventional vapor-compression refrigerator for precooling a mixed-gas JT system Alexeev *et al.* [14] achieved an overall Carnot efficiency of 18% at 100 K. Marquardt *et al.* [15] discuss the optimization of gas mixtures for a given temperature range and show how a mixed-gas JT cryocooler can be used for a cryogenic catheter only 3 mm in diameter. These miniature systems could also be used for cooling small HTS electronic devices.

2) *Brayton and Claude Refrigerators*: Cooling in Brayton cryocoolers occurs as the expanding gas does work. Fig. 4(b) shows a reciprocating expansion engine for this purpose, but an expansion turbine supported on gas bearings is more commonly used for reliability reasons, especially in large systems. According to the first law of thermodynamics, the heat absorbed with an ideal gas in the Brayton cycle is equal to the work produced. The Brayton process is then more efficient than the JT cycle and it requires a much lower pressure ratio. The Brayton cycle is commonly used in large liquefaction plants with the addition of a JT final expansion stage; the combination is called the Claude cycle. For small Brayton cryocoolers, the challenge is fabricating miniature turboexpanders that maintain acceptable expansion efficiency. Turbine diameters of about 6 mm on shafts of 3-mm diameter spinning at 2000–5000 rev/s are typical in systems reviewed by McCormick *et al.* [16] for use in space applications of cooled infrared sensors. Centrifugal compressors providing a pressure ratio of about 1.6 with a low-side pressure of 0.1 MPa are used with these systems. A similar system [17] has been installed on the Hubble Space Telescope, which provides 7 W of cooling at 70 K. The working fluid used in the turbo-Brayton cryocoolers is usually neon when operating above 35 K, with helium required for lower temperatures.

### B. Regenerative (Oscillating Flow) Gas Cycles

These cryocoolers operate with oscillating pressures and mass flows in the cold head. The working fluid is almost always helium gas. The oscillating pressure can be generated with a valveless compressor (pressure oscillator) as shown in Fig. 4 for the Stirling and pulse tube cryocoolers, or with valves that switch the cold head between a low and high pressure source, as shown for the GM cryocooler. In the GM case, a conventional compressor with inlet and outlet valves generates the high- and low-pressure sources. An oil-lubricated compressor is normally used with oil removal equipment placed in the high-pressure line. The use of valves

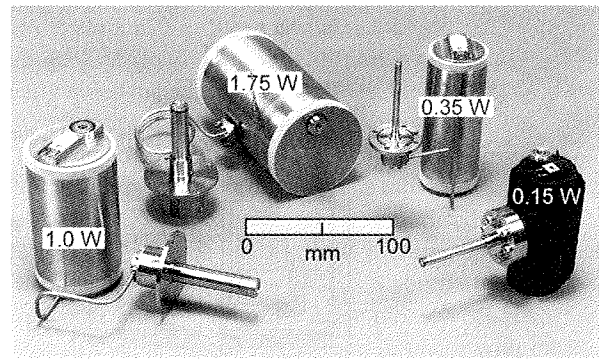

Fig. 6. Four sizes of Stirling cryocoolers with dual-opposed linear compressors. Courtesy Texas Instruments/DRS Infrared Technologies.

greatly reduces the efficiency of the system. Pulse tube cryocoolers can use either source of pressure oscillations, even though Fig. 4(d) indicates the use of a valveless compressor. The valved compressors are air conditioning or refrigeration compressors modified for use with helium gas and used primarily for commercial applications of cryocoolers where low cost is very important. The modification for helium use involves oil injection into the gas before compression to reduce the temperature rise during compression.

1) *Stirling Refrigerator*: The Stirling cycle was invented in 1815 by R. Stirling for use as a prime mover [5], [6]. Though used some in the latter part of that century as a refrigerator, it was not until the middle of the 20th century that it was first used to liquefy air and soon thereafter for cooling infrared sensors for tactical military applications. Stirling cryocoolers have cooldown times of a few minutes compared with a few seconds for JT cryocoolers, so they are seldom used on missiles for guidance. The long history of the Stirling cryocooler in cooling infrared equipment has resulted in the development of models tailored specifically to that application available from several manufacturers. The refrigeration powers of these models, which range from 0.15 to 1.75 W, are also appropriate for many superconducting electronic applications, though problems of reliability and EMI are important considerations.

A pressure oscillation by itself in a system would simply cause the temperature to oscillate everywhere in the system and produce no refrigeration. In the Stirling cryocooler, the second moving component, the displacer, is required to separate the heating and cooling effects by causing motion of the gas in the proper phase relationship with the pressure oscillation. When the displacer in Fig. 4(c) is moved downward, the helium gas is displaced to the warm end of the system through the regenerator. The piston in the compressor then compresses the gas, and the heat of compression is removed by heat exchange with the ambient. Next, the displacer is moved up to displace the gas through the regenerator to the cold end of the system. The piston then expands the gas, now located at the cold end, and the cooled gas absorbs heat from the system it is cooling before the displacer forces the gas back to the warm end through the regenerator. Stirling cryocoolers usually have the regenerator inside the displacer in-

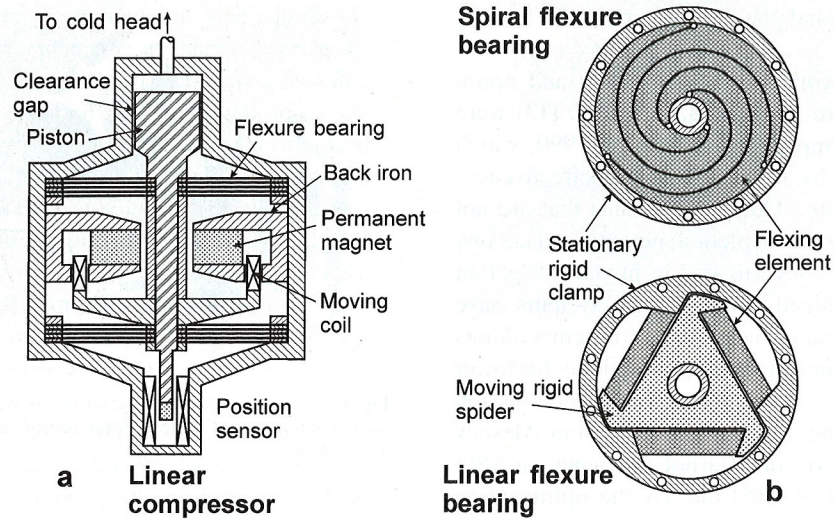

Fig. 7. Schematic of: (a) linear compressor with flexure bearings and (b) two types of flexure bearings.

stead of externally as shown in Fig. 4(c). The resulting single cylinder provides a convenient geometry, called a cold finger.

In practice, motion of the piston and the displacer are nearly sinusoidal. The correct phasing occurs when the volume variation in the cold expansion space leads the volume variation in the warm compression space by about  $90^\circ$ . With this condition, the mass flow or volume flow through the regenerator is approximately in phase with the pressure. In analogy with ac electrical systems, real power flows only when current and voltage are in phase with each other. The moving displacer reversibly extracts work from the gas at the cold end and transmits it to the warm end where it contributes some to the compression work. In an ideal system, with isothermal compression and expansion and a perfect regenerator, the process is reversible. Thus, the COP for the ideal Stirling refrigerator is the same as the Carnot COP given by (4). Practical Stirling cryocoolers have COP values at 80 K that range from about 1 to 20% of the Carnot value, although a few large systems have reported values up to about 40% of Carnot [5], [6]. Large helium liquefaction plants may operate at about 30% of Carnot and large air liquefaction plants operate at about 50% of Carnot.

Fig. 6 shows the four sizes of Stirling cryocoolers that are currently used for military tactical applications of infrared sensors. All except the smallest cooler in this figure are split systems in which the cold finger can be located a short distance from the compressor. The refrigeration powers listed for each cooler are for a temperature of about 77–80 K, except the 1.75-W system, which is for a temperature of 67 K. They have efficiencies of about 10% of Carnot. All of the coolers shown in Fig. 6 use linear drive motors with dual-opposed pistons to reduce vibration. The linear drive reduces side forces between the piston and the cylinder and the mean time to failure (MTTF) is at least 4000 h (time at which half of the units have failed). The displacer is driven pneumatically with the oscillating pressure in the system and because there is only one displacer it gives rise to considerable vibration. The cost of a single unit ranges from about \$5000

to \$10 000. Efforts are currently underway to increase the MTTF of these Stirling cryocoolers, since they are the least reliable component in an infrared system.

The development of cryocoolers for space applications has led to greatly improved reliabilities, and a MTTF of ten years is now usually specified for these applications. The Stirling cooler was first used in these space applications after flexure bearings were developed [18] for supporting the piston and displacers in their respective cylinders with little or no contact in a clearance gap of about  $15 \mu\text{m}$ . Fig. 7 shows two examples of flexure bearing geometries used in a compressor. These flexure-supported Stirling cryocoolers were initially very expensive, but advances in manufacturing have reduced the price so these flexure supports are now being investigated for compressor use in tactical and commercial applications. Pulse tube cryocoolers can use the same type of compressor.

2) *GM Refrigerator*: The cold head of the GM refrigerator is the same as that of the Stirling refrigerator. They both use a moving displacer, usually with a regenerator matrix on the inside. Thus, the operating principles for the cold head are the same as for the Stirling cryocooler. However, the displacer of a GM cryocooler generally operates at frequencies of about 1–2 Hz as opposed to 30–60 Hz for a Stirling cryocooler. The lower frequency provides a longer lifetime for the rubbing seal on the GM displacer. The displacer is driven either with an electric motor synchronously with the valve operation or pneumatically by the pressure oscillation.

The pressure oscillation in GM cryocoolers is provided by valves (rotary, slide, or poppet) located at the warm end of the cold head (or expander unit) that switch between a low- and a high-pressure source. These steady (or dc) pressure sources are provided with a conventional oil-lubricated compressor made by the millions for the air conditioning industry. Such compressors can be valved piston or scroll type compressors. They usually operate at a frequency of 50 or 60 Hz to keep the compressor compact. The compressor package also contains oil cooling and removal equipment as well as the after-cooler (heat exchanger to remove the heat of compression).



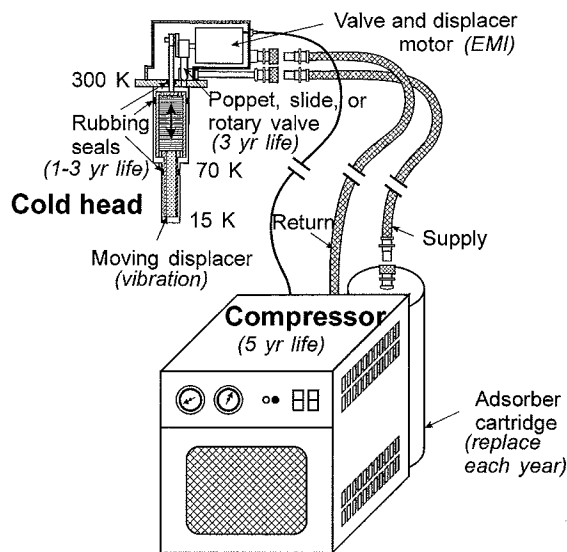

Fig. 8. Drawing of a two-stage GM cryocooler showing sources of concern to users.

The GM compressor package is usually much larger than the cold head, but it can be located quite some distance from the cold head (10 m or even more) and connected by two flexible gas lines and an electrical line for driving the displacer and valves. Fig. 8 shows a drawing of a typical two-stage GM cryocooler system. Potential problem areas for users are indicated in the figure.

The GM cryocooler was first developed [19], [20] in the late 1950s and is described in more detail elsewhere [5], [6], [18]. They were developed as a lower cost alternative to the Claude cycle because the valves and seals could be located at room temperature. Some early single-stage versions were used in cooling infrared sensors for the military. The GM cryocoolers are most commonly used in two-stage 15 K versions for cryopumps in the semiconductor fabrication industry. About 20 000 per year have been made worldwide during the peak in the semiconductor industry with unit costs ranging from about \$10 000 to \$20 000. The GM cryocooler is also used for cooling radiation shields to 10–15 K in MRI systems to reduce the boiloff rate of liquid helium or in some cases used to reliquefy the helium at 4.2 K. Single-stage units for temperatures above about 30 K are less expensive. Refrigeration powers at 80 K generally range from about 10 to 300 W with input powers ranging from about 800 W to 7 kW. The oil-lubricated compressors have lifetimes of at least five years, but the adsorber cartridge for oil removal must be replaced once every year or two. Replacement of seals on the displacer must be performed about once per year.

Most of the recent developments in GM cryocoolers have involved the use of high heat capacity regenerator materials to reach temperatures of 4 K without the aid of a JT stage. Rare-earth materials that undergo magnetic transitions in the range of 4–20 K are generally used for these new regenerators. With lead spheres replaced by  $\text{Er}_3\text{Ni}$  spheres in the second stage, Kuriyama *et al.* [21] achieved a minimum temperature of 4.5 K with a two-stage GM cryocooler in 1989.

The development in Japan of the technique [22] to produce high-quality spheres of many different rare-earth materials greatly aided the advancement of 4-K GM refrigerators. The cost of the rare-earth materials significantly increases the cost of the 4-K GM cryocoolers.

3) *Pulse Tube Refrigerators:* The moving displacer in the Stirling and GM cryocoolers has several disadvantages. It is a source of vibration, has a limited lifetime, and contributes to axial heat conduction as well as a shuttle heat loss. The displacer is eliminated in the pulse tube cryocooler, shown in Fig. 4(d). The proper gas motion in phase with the pressure oscillation is achieved by the use of an orifice, along with a reservoir volume to store the gas during a half cycle. The reservoir volume is large enough that negligible pressure oscillation occurs in it during the oscillating flow. The oscillating flow through the orifice separates the heating and cooling effects just as the displacer does for the Stirling and GM refrigerators. The orifice pulse tube refrigerator (OPTR) ideally operates with adiabatic compression and expansion in the pulse tube. Thus, for a given frequency, there is a lower limit diameter of the pulse tube required to maintain adiabatic processes.

The four steps in the cycle are as follows.

- 1) The piston moves down to compress the gas (helium) in the pulse tube.
- 2) Because this heated compressed gas is at a higher pressure than the average in the reservoir, it flows through the orifice into the reservoir and exchanges heat with the ambient through the heat exchanger at the warm end of the pulse tube. The flow stops when the pressure in the pulse tube is reduced to the average pressure.
- 3) The piston moves up and expands the gas adiabatically in the pulse tube.
- 4) This cold low-pressure gas in the pulse tube is forced past the cold end heat exchanger by the gas flow from the reservoir into the pulse tube through the orifice. The flow stops when the pressure in the pulse tube reaches to the average pressure. The cycle then repeats.

One function of the pulse tube is to insulate the processes at its two ends. That is, it must be large enough that gas flowing from either the warm end or the cold end traverses only part way through the pulse tube before flow is reversed. Gas in the middle portion of the pulse tube never leaves the pulse tube and forms a temperature gradient that insulates the ends. Roughly speaking, the gas in the pulse tube is divided into three segments, with the middle segment acting like a displacer but consisting of gas rather than a solid material. For this gas plug to effectively insulate the ends of the pulse tube, turbulence in the pulse tube must be minimized. Thus, flow straightening at each end is crucial to the successful operation of the pulse tube refrigerator.

Pulse tube refrigerators that reached a low temperature of 124 K were invented by Gifford and Longworth [23] in the mid-1960s, but that type is different from that shown in Fig. 4(d). In 1984, Mikulin *et al.* [24] introduced the concept of an orifice to the original pulse tube concept and reached 105 K. In 1985, Radebaugh *et al.* [25] changed the location

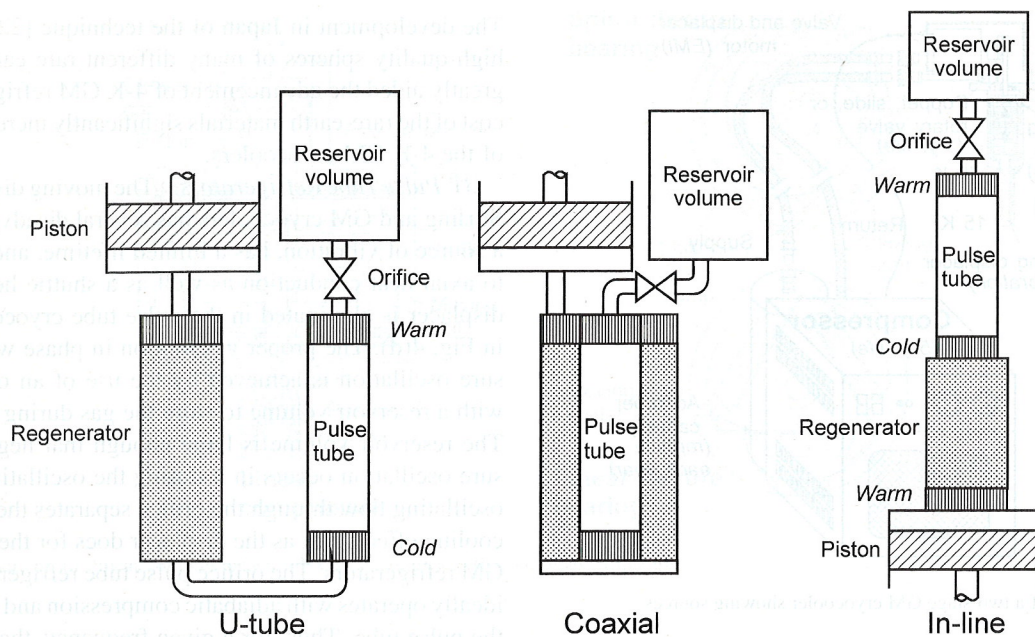

Fig. 9. Three different geometries for pulse tube refrigerators.

of the orifice to that shown in Fig. 4(d) and reached 60 K. Further improvements since then have led to a low temperature limit of about 20 K with one stage and 2 K with two stages. (See discussion in [26].)

Three different geometries have been used with pulse tube cryocoolers as shown in Fig. 9. The inline arrangement is the most efficient because it requires no void space at the cold end to reverse the flow direction, nor does it introduce turbulence into the pulse tube from the flow reversal. The disadvantage is the possible awkwardness associated with having the cold region located between the two warm ends. The most compact arrangement and the one most like the geometry of the Stirling cryocooler is the coaxial arrangement. That geometry has the potential problem of a mismatch of temperature profiles in the regenerator and in the pulse tube that could lead to steady heat flow between the two components and a reduced efficiency. However, that problem has been minimized, and a coaxial geometry was developed at the National Institute of Standards and Technology (NIST), Boulder, CO, as an oxygen liquefier for NASA with an efficiency of 17% of Carnot [27]. For the majority of applications, the U-tube geometry is used.

The absence of the moving displacer in pulse tube cryocoolers gives them many potential advantages over Stirling cryocoolers. These advantages include higher reliability, lower cost, lower vibration, less EMI, and insensitivity to large side forces on the cold region. Disadvantages are difficulty in scaling to very small sizes (less than about 10-W input power) and the possibility of convective instabilities in the pulse tube when operated with the cold end up or horizontal in a gravity environment. Early pulse tube cryocoolers were not nearly as efficient as Stirling cryocoolers, but advances in the last ten years have brought pulse tube refrigerators to the point of being the most efficient of all cryocoolers. The improved efficiencies have been a result of a better un-

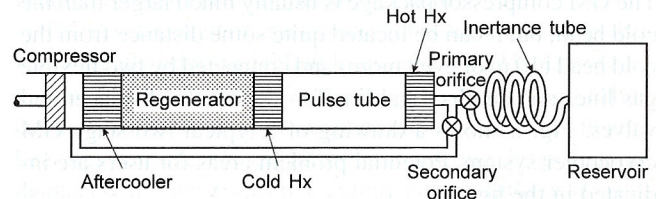
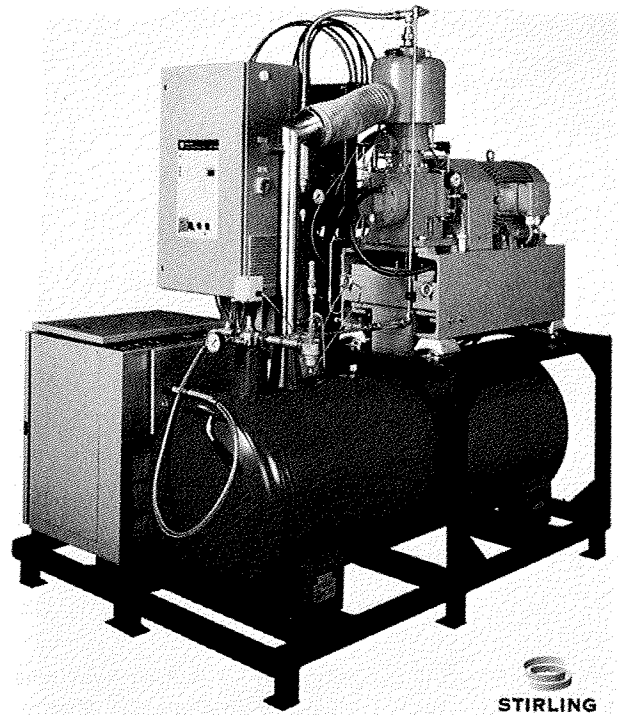
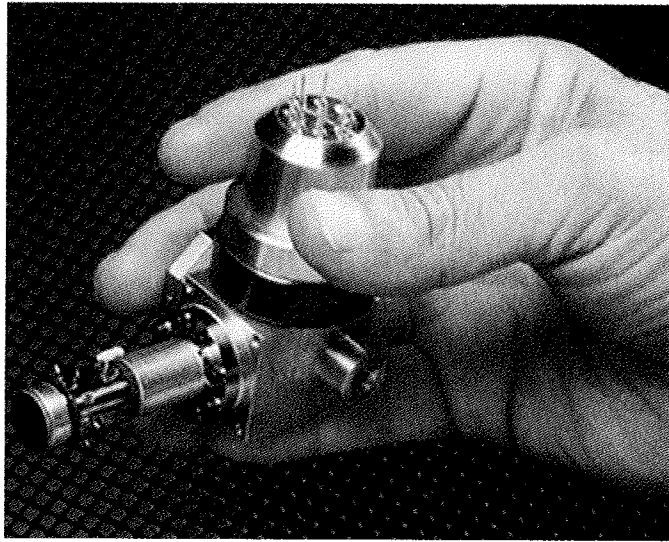

Fig. 10. Schematic of pulse tube refrigerator with secondary orifice (double inlet) and inertance tube.

derstanding of the cycle and the introduction of two passive components, a secondary orifice and an inertance tube, that can shift the phase between the flow and the pressure to a more optimum value compared with the phase established by the primary orifice. Fig. 10 shows the location of these two new components in relation to the pulse tube. The secondary orifice allows some of the oscillating flow to bypass the regenerator and reduce the regenerator loss. The inertance tube is a long, small-diameter tube that shifts the phase because of the inertia of the gas oscillating through it, analogous to an inductor that shifts the phase between the current and voltage. The secondary orifice is effective in any size refrigerator, but the inertance tube is more effective in larger systems. A disadvantage of the secondary orifice (often referred to as a double inlet pulse tube refrigerator) is that it permits some dc flow to occur around the continuous loop that it forms with the regenerator and the pulse tube. See [26] for more details.

4) *Examples of Regenerative Cryocoolers:* Stirling refrigerators are available in a very wide range of sizes. Fig. 11 shows an example of a very small and very large Stirling refrigerator. Both use rotary motors with crankshafts rather than the linear motors shown in Fig. 6. The smallest Stirling cooler can provide 0.15 W of cooling at 80 K with only 3 W of input power. The low input power allows it to be operated



**Fig. 11.** Photos of miniature and large Stirling refrigerators. Courtesy FLIR/Inframetrics and Stirling Cryogenics & Refrigeration.

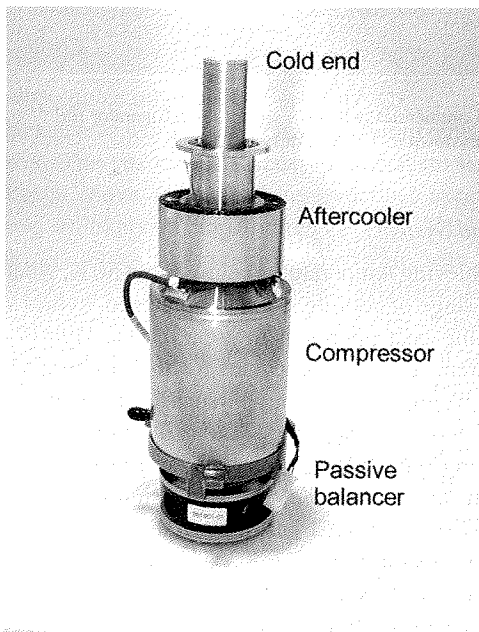

**Fig. 12.** Stirling cryocooler used for cooling HTS microwave filters in cellular phone base stations. Courtesy STI.

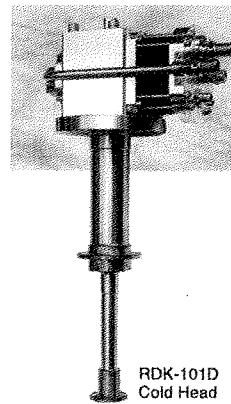

**Fig. 13.** Two-stage cold head and compressor for small 4-K GM refrigerator. Courtesy Sumitomo Heavy Industries.

This cooler is used for cooling HTS microwave filters in cellular phone base stations.

Fig. 13 shows an example of a two-stage GM refrigerator that can be used for cooling LTS electronic devices to 4.2 K. It produces 0.1 W of refrigeration at 4.2 K with a power input of 1.3 kW using single-phase power at 120 V. Large single-stage GM refrigerators may be used for cooling HTS power systems to about 30 K. One of the largest produces 100 W at 30 K with a power input of 7.2 kW.

Fig. 14 shows a typical commercial pulse tube refrigerator. It is a single-stage system that produces 15 W of cooling at 77 K with a power input of 2.3 kW. It is a GM-type pulse tube in the sense that it uses a GM compressor with an external rotary valve to provide for the oscillating pressures. The commercial two-stage pulse tube refrigerator shown in

from a battery source and is commonly used for cooling in an infrared camcorder. The large Stirling refrigerator provides 500 W of cooling at 65 K with 12 kW of input power. Even larger systems are available that simply add more cylinders (up to four) in parallel. Fig. 12 shows a Stirling cryocooler that uses a linear motor and gas bearings to support the piston and displacer in their respective cylinders with no contact. It provides 6 W of cooling at 77 K with 100 W of input power.

ube  
Reservoir

o passive  
tube, that  
sure to a  
established  
of these  
The seco  
o bypass  
nertance  
hase bet  
t, analo  
e current  
y size re  
in larger  
often re  
is that it  
ous loop  
See [26]

rling re-  
s. Fig. 11  
Stirling  
ts rather  
t Stirling  
only 3 W  
operated

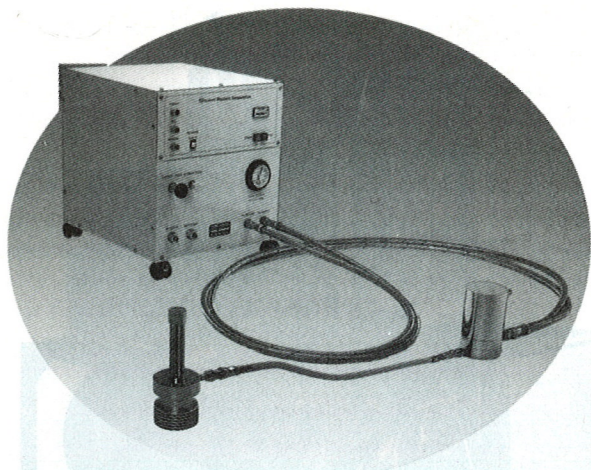

**Fig. 14.** Commercial pulse tube refrigerator with rotary valve and GM compressor. Courtesy Iwatani.

Fig. 15 provides 0.5 W of cooling at 4.2 K with a power input of 5 kW. The first stage is capable of producing 25 W of refrigeration at 65 K. It also is a GM-type pulse tube, but the compressor is not shown here. The operating frequency is about 1 Hz. The reservoir and rotary valve are located at the warm end of this cold head. Both stages are of the U-tube geometry.

The Stirling-type pulse tube should be used when high efficiency is important. With such a driver, there are no valves. Fig. 16 shows a space-qualified pulse tube cooler with the compressor on the bottom and the cold head above it. The cold head utilizes the inline geometry, which requires the cold plate to be near the center instead of at the end of the cold head. It provides 7.3 W of cooling at 80 K with 107 W of input power to the compressor [28]–[30]. The efficiency is 19% of Carnot, the highest for any small cryocooler in this temperature range. It has a mass of 4.3 kg. The Stirling-type compressor (pressure oscillator with 67-Hz resonance frequency) is a dual-opposed linear drive system that uses flexure bearings to eliminate rubbing contact. Its expected lifetime is at least ten years. This cooler uses an inertance tube and a reservoir that has an annular geometry around the left side of the compressor. Fig. 17 shows a large Stirling-type pulse tube refrigerator under development at NIST for cooling to 30 K utilizing liquid nitrogen for pre-cooling at 77 K. It could be used for liquefying neon or cooling large superconducting systems, such as motors, generators, or transformers. The 20-kW compressor also uses flexure bearings for long life and has an operating frequency of about 60 Hz. The design goal of 500 W of refrigeration at 30 K has not been achieved yet because of problems with flow and temperature uniformity in the second stage regenerator. Such a problem has been observed in other large pulse tube systems and must be overcome to be useful for cooling HTS power systems. Research on such large systems is being actively pursued.

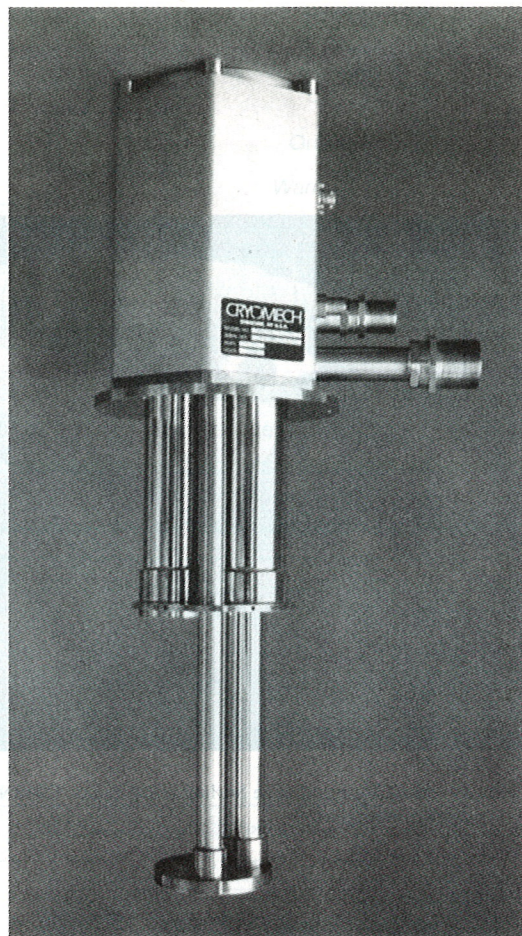

**Fig. 15.** Commercial two-stage pulse tube refrigerator for temperatures down to 4 K. Courtesy Cryomech.

### C. Hybrid Systems

For achieving temperatures below about 50 K, where more than one stage of cooling is commonly used, hybrid systems may be the best approach in some cases. Hybrid system use different refrigeration cycles for the different stages. A common example now being pursued for achieving temperatures of 4–6 K in space applications is a Stirling cryocooler or a Stirling-type pulse tube cryocooler precooling a helium JT system to about 18 K [31]. Expansion of the helium in the JT system to about 1 bar through the JT orifice achieves the final temperature of 4–6 K. This hybrid approach eliminates the problem associated with low regenerator heat capacities below 20 K. Instead, it uses recuperative heat exchangers for this low temperature range. Because of the low inversion temperature of helium (about 40 K) it must be pre-cooled to temperatures significantly less than that to provide high efficiency in a JT cycle. The disadvantage of this hybrid approach is the need for a second compressor for the JT system. Temperatures of 4 K are easily obtained with commercial GM cryocoolers or GM-type pulse tubes, but such systems can not be used for space applications because of the oil-lubricated compressor and their low efficiency. However, the higher frequency associated with Stirling-type

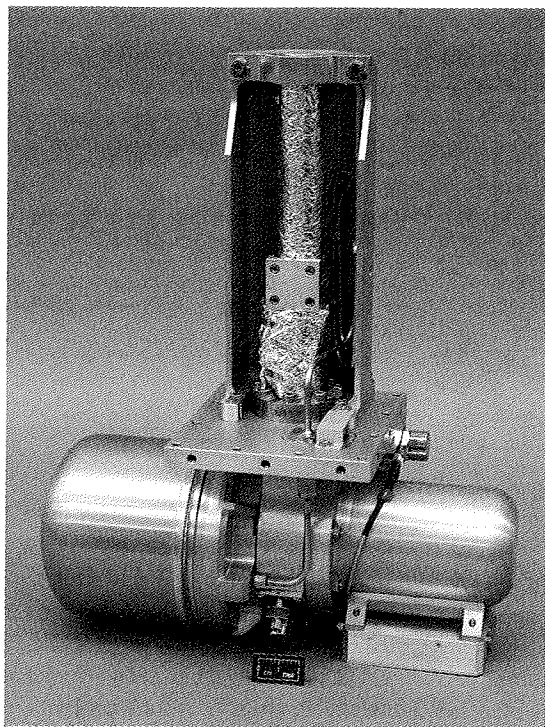

Fig. 16. High-efficiency pulse tube cryocooler for space. Courtesy TRW.

cryocoolers makes efficient operation of the regenerator more difficult at such low temperatures. Recently a temperature of 5.4 K was achieved with a high-frequency (31 Hz) Stirling-type pulse tube cryocooler [32].

Hybrid systems would also be used to obtain temperatures below 1 K. The gas cycles discussed so far are limited to temperatures above about 2 K for practical applications. To achieve millikelvin temperatures ( $T < 1$  K) the lower stage can be: 1) an adsorption-pumped  $^3\text{He}$  bath [33]; 2) a superfluid vortex cooler [34]; 3) an adiabatic demagnetization refrigerator (ADR) [35]; or 4) a  $^3\text{He}$ - $^4\text{He}$  dilution refrigerator [36]. Only the last two are capable of achieving temperatures of 100 mK and below. Such temperatures are required to cool a microcalorimeter utilizing a superconducting transition edge sensor (TES) for detection of low-energy X-rays [37]. These thin-film sensors may be used in future space telescopes and in analytical instruments for semiconductor studies. A new solid-state microrefrigerator made with normal-metal/insulator/superconductor (NIS) tunnel junctions just recently achieved a low temperature of about 100 mK with a bath temperature of about 0.3 K [38]. A bath temperature of 0.25 K can be achieved with a pumped  $^3\text{He}$  bath. A TES cooled with a NIS microrefrigerator was just recently demonstrated [39].

#### IV. CRYOCOOLER COMPARISONS

The typical operating regions for the various cryocoolers are shown in Fig. 18. Some of these boundaries have not been fully explored, especially for the larger size pulse tube refrigerators. The same chart shows the operating regions for various applications, including most of the superconducting

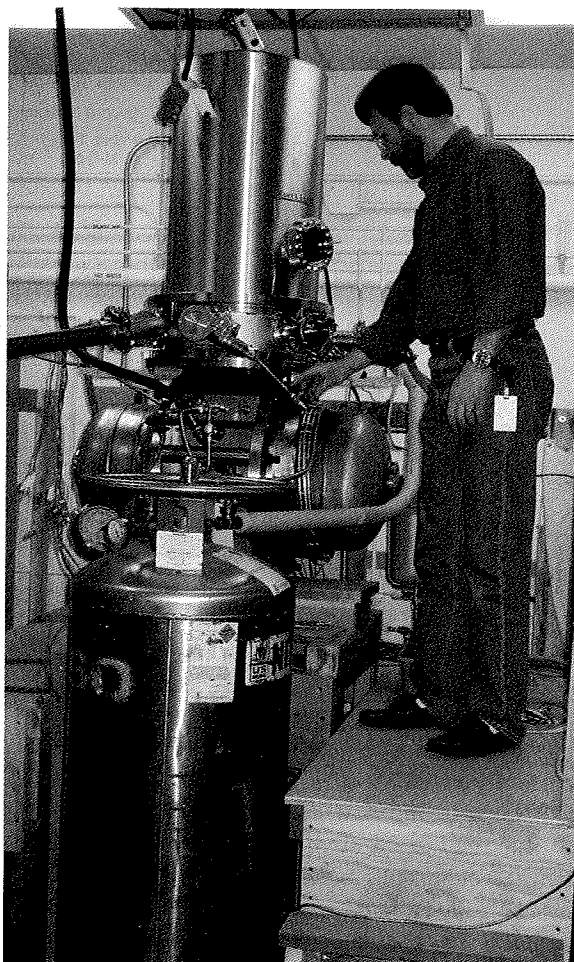

Fig. 17. Large pulse tube neon liquefier with 20-kW flexure bearing compressor.

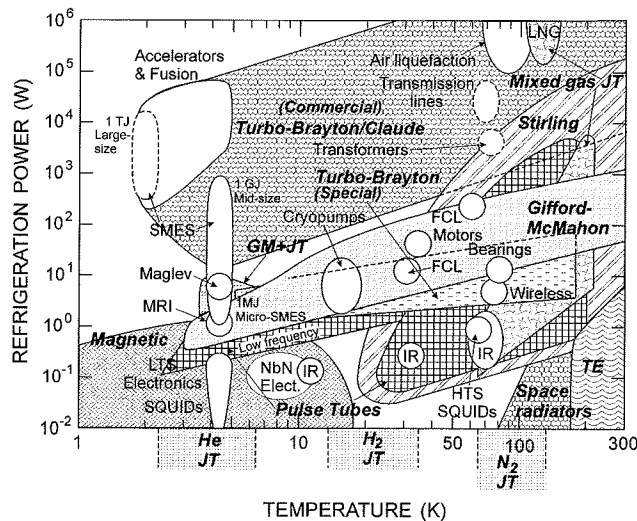

Fig. 18. Application map of cryocoolers as shown in Fig. 1 (clear regions) superimposed on typical operating regions (crosshatched) for various types of cryocoolers.

applications. Fig. 19 compares efficiencies of cryocoolers types operating at 80 K as a function of the input power to the compressor. The data used in this figure are from the last ten years and include mostly high-efficiency coolers in each

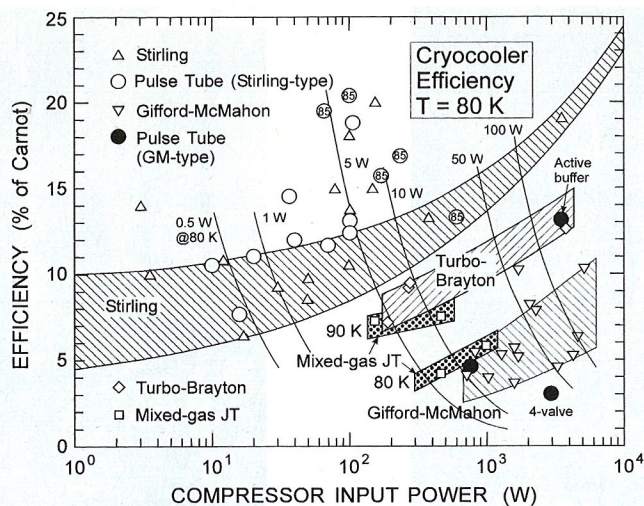

Fig. 19. Efficiencies of various types of cryocoolers at 80 K.

type. Two facts emerge from this figure. The first is that efficiencies improve with larger sizes and the second is that pulse tube refrigerators with Stirling-like (valveless) compressors are at least as efficient, if not more, as Stirling cryocoolers. The Stirling cryocooler shown in Fig. 12 achieved an efficiency of 20% of Carnot at 80 K. An efficiency of 19% of Carnot at 80 K was recently achieved [28], [29] in a pulse tube cryocooler similar to that shown in Fig. 16. The efficiencies of mixed-gas JT cryocoolers increases rapidly as the temperature is increased from 80 to 90 K, whereas the efficiency of the other cryocoolers changes very little with temperature over this temperature range. The efficiencies of these small cryocoolers has increased considerably since 1974 when the survey by Strobridge [2] showed an average efficiency of about 2% of Carnot at a refrigeration power of 1 W.

#### V. INTEGRATION OF SUPERCONDUCTORS WITH CRYOCOOLERS

One of the most challenging problems in cooling superconductors with cryocoolers is that of reducing the associated vibration and EMI caused by the motor and other moving parts. The problem is most serious with superconducting quantum interference device (SQUID) devices because of their extreme sensitivity to magnetic fields and to vibration in the earth's magnetic field. Thus, we concentrate in this section on SQUID applications. In the case of power applications of superconductors, the major concern is efficiency, cost, reliability, and how to distribute the cold from a cold head to a large superconducting device. In that case, the cryocooler is often used to liquefy the boiloff from a cryogenic bath in which the superconductor is immersed.

To reduce noise in a superconducting device caused by the cryocooler, the following points should be considered:

- 1) selection of cryocooler type;
- 2) selection of materials;
- 3) distance between cryocooler and superconductor;
- 4) mounting platforms;
- 5) shielding;

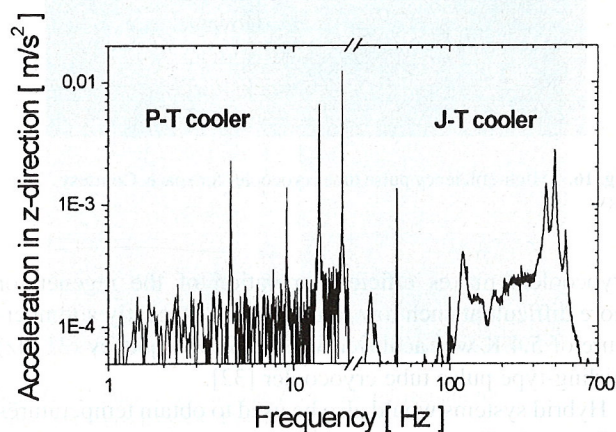

Fig. 20. Vibration at cold tip of pulse tube and mixed-gas JT cryocoolers. Reproduced from [43] by permission of IEEE.

- 6) thermal damping;
- 7) signal processing.

In regard to cryocooler types, the JT and pulse tube cryocoolers are good choices because they have no cold moving parts. Because the pulse tube cryocooler uses oscillating pressures the temperature of the cold tip will also oscillate slightly at the operating frequency.

A combination of techniques such as magnetic shielding of the Stirling compressor, use of dual, opposed pistons and displacers, and separation of SQUIDs from the cold finger by flexible copper braids was used for a high  $T_c$  SQUID heart scanner cooled with a pair of Stirling cryocoolers [40]. A hybrid JT/GM cryocooler has been used for cooling a 61-channel magnetoencephalography (MEG) system [41]. In this case, the final JT stage separates the SQUIDs from the moving displacer in the GM refrigerator. The noise of the system was about 4 pT peak to peak, which was reduced further by digital filtering. With a careful selection of materials and a separate support for a high  $T_c$  SQUID magnetometer in a  $\mu$  metal shield, Lienerth *et al.* [42] have used a pulse tube cooler for the system and achieved a white noise level above 1 kHz of 35 fT/ $\sqrt{\text{Hz}}$  compared with 45 fT/ $\sqrt{\text{Hz}}$  for liquid nitrogen cooling. In fact, the white noise level for cooling with

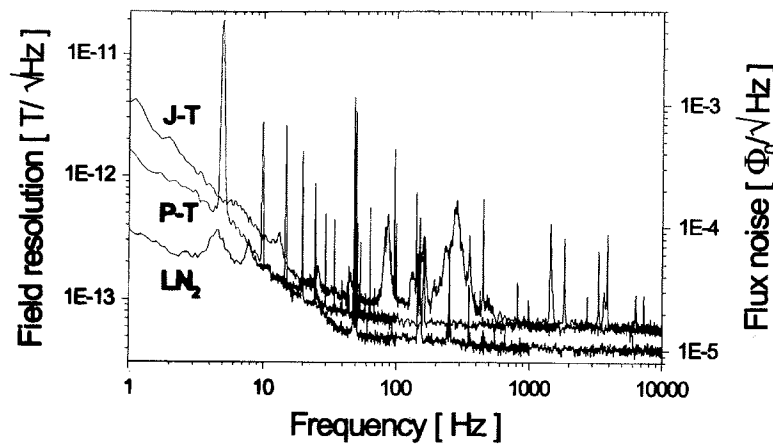

Fig. 21. Field noise in a SQUID caused by various cooling methods. Reproduced from [43] by permission of IEEE.

the pulse tube was less than with liquid nitrogen cooling for all frequencies above about 2 Hz. However, the pulse tube produced sharp peaks in the noise spectra at the operating frequency of 4.6 Hz and its harmonics. Earlier measurements in the same laboratory compared vibration and field noise spectra at the cold tips of a mixed-gas JT cooler and a pulse tube cooler [43]. These comparisons of vibration and field noise are shown in Figs. 20 and 21. Except for the sharp peaks in the noise spectra at the operating frequency and its harmonics, the pulse tube cooler produced less noise than the JT cooler and less noise than liquid nitrogen cooling at frequencies above about 40 Hz. The broad vibration and noise peaks in the frequency range from 100 to 500 Hz with the JT cooler may be caused by turbulent fluid flow. There is still much more work to be done regarding some of the other cryocooler problems, especially cost, reliability, and in some cases efficiency before many superconductors can easily make it to the marketplace.

## VI. CONCLUSION

Because superconductors can only operate at temperatures below about 80 K in practical applications, refrigeration becomes an enabling technology for them. Liquid nitrogen or liquid helium are normally used for cooling superconductors in laboratory applications, but the replenishment of these stored cryogens is not a very satisfactory operating procedure for most commercial or military applications. Instead, the marketplace usually demands the cooling of superconductors be carried out with a closed-cycle cryocooler whose presence is not very obvious to the end user. Cryocooler characteristics such as reliability, efficiency, size, weight, vibration, EMI, heat rejection, and cost often represent problems that reveal the presence of the cryocooler to the end user. Selection of the optimum cryocooler type for the particular application can minimize the problems. The characteristics of the main cryocooler types were reviewed in this paper to aid in the selection process. The recuperative cycles are represented by the JT, Brayton, and Claude cryocoolers in which there is a steady flow of refrigerant around the cycle

driven by the compressor. The regenerative cycles are represented by the Stirling, GM, and pulse tube cryocoolers in which there is an oscillating pressure and flow in the cold head. Other refrigeration methods for achieving temperatures down to 0.05 K were briefly mentioned, but they are beginning to open up some new application areas for superconductors. Significant advances in all the cryocooler types have occurred in the past 15 years or so, which has permitted more superconductor applications to be marketed successfully. The method of integrating the superconductor with a cryocooler can minimize potential problems, such as vibration, EMI, and heat transfer. The design of any commercial superconducting system should consider the cryocooler characteristics and integration issues at the beginning of the design phase.

## REFERENCES

- [1] H. Dunmire, "U.S. army cryocooler status update," in *Workshop Military and Commercial Applications for Low Cost Cryocoolers (MCALCII)*, San Diego, CA, 1998.
- [2] T. R. Strobridge, "Cryogenic refrigerators—An updated survey," Nat. Bureau Standards, Washington, DC, NBS Tech. Note 655, 1974.
- [3] J. L. Bruning, R. Torrison, R. Radebaugh, and M. Nisenoff, "Survey of cryocoolers for electronic applications (C-SEA)," in *Cryocoolers 10*. New York: Plenum, 1999, pp. 829–835.
- [4] M. ter Brake and G. F. M. Wiegierinck, "Low power cryocooler survey," *Cryogenics*, vol. 42, no. 11, pp. 705–718, Nov. 2002.
- [5] G. Walker, *Cryocoolers*. New York: Plenum, 1983.
- [6] G. Walker and E. R. Bingham, *Low-Capacity Cryogenic Refrigeration*. Oxford, U.K.: Oxford Univ. Press, 1994.
- [7] W. A. Little, "Recent developments in Joule-Thomson cooling: Gases, coolers, and compressors," in *Proc. 5th Int. Conf. Cryocoolers*, 1988, pp. 3–11.
- [8] W. J. Podbielniak, "Art of refrigeration," U.S. Patent 2041 725, 1936.
- [9] W. A. Little, "Kleemenko cycle coolers: Low cost refrigeration at cryogenic temperatures," in *Proc. 17th Int. Cryogenic Engineering Conf.*, 1998, pp. 1–9.
- [10] M. J. Boiarski, V. M. Brodianski, and R. C. Longworth, "Retrospective of mixed-refrigerant technology and modern status of cryocoolers based on one-stage, oil-lubricated compressors," *Adv. Cryogenic Eng.*, vol. 43, pp. 1701–1708, 1998.
- [11] D. J. Missimer, "Auto-refrigerating cascade (ARC) systems—An overview," presented at the 10th Intersociety Cryogenic Symp., AIChE Spring National Meeting, Houston, TX, 1994.
- [12] R. Radebaugh, "Recent developments in cryocoolers," in *Proc. 19th Int. Congr. Refrigeration*, 1995, pp. 973–989.

- [13] E. Luo, M. Gong, Y. Zhou, and L. Zhang, "Experimental investigation of a mixed-refrigerant J-T cryocooler operating from 30 to 60 K," *Adv. Cryogenic Eng.*, vol. 45, pp. 315–321, 2000.
- [14] A. Alexeev, Ch. Haberstroh, and H. Quack, "Mixed gas J-T cryocooler with precooling stage," in *Cryocoolers 10*. New York: Plenum, 1999, pp. 475–479.
- [15] E. D. Marquardt, R. Radebaugh, and J. Dobak, "A cryogenic catheter for treating heart arrhythmia," *Adv. Cryogenic Eng.*, vol. 43, pp. 903–910, 1998.
- [16] J. A. McCormick, W. L. Swift, and H. Sixsmith, "Progress on the development of miniature turbomachines for low-capacity reverse-Brayton cryocoolers," in *Cryocoolers 9*. New York: Plenum, 1997, pp. 475–483.
- [17] G. Nellis, F. Dolan, J. McCormick, W. Swift, H. Sixsmith, J. Gibbon, and S. Castles, "Reverse brayton cryocooler for NICMOS," in *Cryocoolers 10*. New York: Plenum, 1999, pp. 431–438.
- [18] A. Ravex, "Small cryocoolers," in *Handbook of Applied Superconductivity*, B. Seeber, Ed. Bristol, MA: Inst. Physics, 1998, vol. 1, pp. 721–746.
- [19] W. E. Gifford and H. O. McMahon, "A new refrigeration process," presented at the 10th Int. Congr. Refrigeration, Copenhagen, Denmark, 1959.
- [20] H. O. McMahon and W. E. Gifford, "A new low-temperature gas expansion cycle," *Adv. Cryogenic Eng.*, vol. 5, pp. 354–372, 1960.
- [21] T. Kuriyama, R. Hakamada, H. Nakagome, Y. Tokai, M. Sahashi, R. Li, O. Yoshida, K. Matsumoto, and T. Hashimoto, "High efficiency two-stage GM refrigerator with magnetic material in the liquid helium temperature region," *Adv. Cryogenic Eng.*, vol. 35, pp. 1261–1269, 1990.
- [22] M. Sahashi, Y. Tokai, T. Kuriyama, H. Nakagome, R. Li, M. Ogawa, and T. Hashimoto, "New magnetic material  $R_3T$  system with extremely large heat capacities used as heat regenerators," *Adv. Cryogenic Eng.*, vol. 35, pp. 1175–1182, 1990.
- [23] W. E. Gifford and R. C. Longworth, "Pulse tube refrigeration," *Trans. ASME, J. Eng. Ind.*, vol. 86, pp. 247–258, Aug. 1964.
- [24] E. I. Mikulin, A. A. Tarasov, and M. P. Shkrebyonock, "Low temperature expansion pulse tubes," *Adv. Cryogenic Eng.*, vol. 29, pp. 629–637, 1984.
- [25] R. Radebaugh, J. Zimmerman, D. R. Smith, and B. Louie, "A comparison of three types of pulse tube refrigerators: New methods for reaching 60 K," *Adv. Cryogenic Eng.*, vol. 31, pp. 779–789, 1986.
- [26] R. Radebaugh, "Pulse Tube Cryocoolers," in *Low Temperature and Cryogenic Refrigeration*, S. Kakac, H. F. Smirnov, and M. R. Avelino, Eds. Dordrecht, The Netherlands: Kluwer, 2003, pp. 415–434.
- [27] E. D. Marquardt and R. Radebaugh, "Pulse tube oxygen liquefier," *Adv. Cryogenic Eng.*, vol. 45, pp. 457–464, 2000.
- [28] E. Tward, C. K. Chan, J. Raab, T. Nguyen, R. Colbert, and T. Davis, "High efficiency pulse tube cooler," in *Cryocoolers 11*. New York: Plenum, 2001, pp. 163–167, 2001.
- [29] M. Donabedian, D. C. T. Curran, D. S. Glaister, T. Davis, and B. J. Tomlinson, "An overview of the performance and maturity of long-life cryocoolers for space applications," Aerospace Corp., El Segundo, CA, Aersp. Rep. TOR-98(1057)-3, Revision A, 2000.
- [30] E. Tward, C. K. Chan, R. Colbert, C. Jaco, T. Nguyen, R. Orsini, and J. Raab, "High efficiency cryocooler," *Adv. Cryogenic Eng.*, vol. 47, pp. 1077–1084, 2002.
- [31] R. G. Ross Jr. and R. F. Boyle, "NASA space cryocooler programs—An overview," in *Cryocoolers 12*. New York: Plenum, 2003, pp. 1–8.
- [32] J. Olson, T. C. Nast, B. Evtimov, and E. Roth, "Development of a 10 K pulse tube cryocooler for space applications," in *Cryocoolers 12*. New York: Plenum, 2003, pp. 241–246.
- [33] A. Ravex, P. Hernandez, and L. Duband, "Sub-kelvin mechanical coolers," in *Cryocoolers 12*. New York: Plenum, 2003, pp. 669–673.
- [34] I. A. Tanaeva and A. T. A. M. de Waele, "Helium-3 pulse tube cryocooler," in *Cryocoolers 12*. New York: Plenum, 2003, pp. 283–292.
- [35] P. J. Shirron, E. R. Cunavan, M. J. DiPirro, J. Francis, M. Jackson, T. T. King, and J. G. Tuttle, "Progress in the development of a continuous adiabatic demagnetization refrigerator," in *Cryocoolers 12*. New York: Plenum, 2003, pp. 661–668.
- [36] K. Uhlig, " $^3\text{He}/^4\text{He}$  dilution refrigerator with pulse-tube refrigerator precooling," *Cryogenics*, vol. 42, pp. 73–77, 2002.
- [37] D. A. Wollman, K. D. Irwin, G. C. Hilton, L. L. Dulcie, D. E. Newbury, and J. M. Martinis, "High-energy resolution microcalorimeter spectrometer for X-ray microanalysis," *J. Microsc.*, vol. 188, pp. 196–223, 1997.
- [38] A. M. Clark, A. Williams, S. T. Ruggiero, M. L. vanden Berg, and J. N. Ullom, "Practical electron-tunneling refrigerator," *Appl. Phys. Lett.*, vol. 84, pp. 625–627, 2004.
- [39] J. Pekola, R. Schoelkopf, and J. Ullom, "Cryogenics on a chip," *Phys. Today*, pp. 41–47, May 2004.
- [40] C. J. H. A. Blom, H. J. M. ter Brake, H. J. Holland, A. P. Rijpma, and H. Rogalla, "Construction and tests of a high- $T_c$  SQUID-based heart scanner cooled by small Stirling cryocoolers," in *Cryocoolers 10*. New York: Plenum, 1999, pp. 837–846.
- [41] K. Sata, S. Fujimoto, N. Fukui, E. Haraguchi, T. Kido, K. Nishiguchi, and Y.-M. Kang, "Development of SQUID based systems cooled by GM/JT cryocoolers," in *Proc. 16th Int. Cryogenic Engineering Conf.*, 1997, pp. 1173–1176.
- [42] C. Lienert, G. Thummes, and C. Heiden, "Progress in low noise cooling performance of a pulse-tube cooler for HT-SQUID operation," presented at the Applied Superconductivity Conf. (ASC2000), Virginia Beach, VA, Paper 3EF04.
- [43] R. Hohmann, C. Lienert, Y. Zhang, H. Bousack, G. Thummes, and C. Heiden, "Comparison of low noise cooling performance of a Joule-Thomson cooler and a pulse tube cooler using a HT SQUID," *IEEE Trans. Appl. Superconduct.*, vol. 9, pp. 3688–3691, June 1999.



**Ray Radebaugh** received the B.S. degree in engineering physics from the University of Michigan, Ann Arbor, in 1962 and the M.S. and Ph.D. degrees in physics from Purdue University, West Lafayette, IN, in 1965 and 1966, respectively.

He has been a Group Leader of the Cryogenic Technologies Group for the National Institute of Standards and Technology, Boulder, CO, since 1995 and a physicist there since 1966. He has conducted and supervised research on cryogenic refrigeration techniques, such as dilution, electrocaloric, thermoelectric, pulse tube, Stirling, and Joule-Thomson refrigerators, and conducted studies of heat transfer and heat exchangers. He has also been involved in measurements of cryogenic fluid flow and other cryogenic processes. He has published over 120 papers as part of the open literature.

Dr. Radebaugh has received several awards, including the Department of Commerce Gold Medal in 2003, the Silver Medal in 1995, three best paper awards at the Cryogenic Engineering Conferences, the R&D 100 Award in 1990 for the thermoacoustically driven pulse tube refrigerator, and the J&E Hall Gold Medal in 1999 from the Institute of Refrigeration in England for his pioneering work on pulse tube refrigerators. He has been an invited speaker at numerous conferences, including the plenary speaker at the 1996 International Cryogenic Engineering Conference and the 1998 Applied Superconductivity Conference. He has taught more than 20 short courses on cryocoolers since 1981.